

3590 portal

Large-area computer stitcher

Free space

on 1200 x 700 mm

...and more

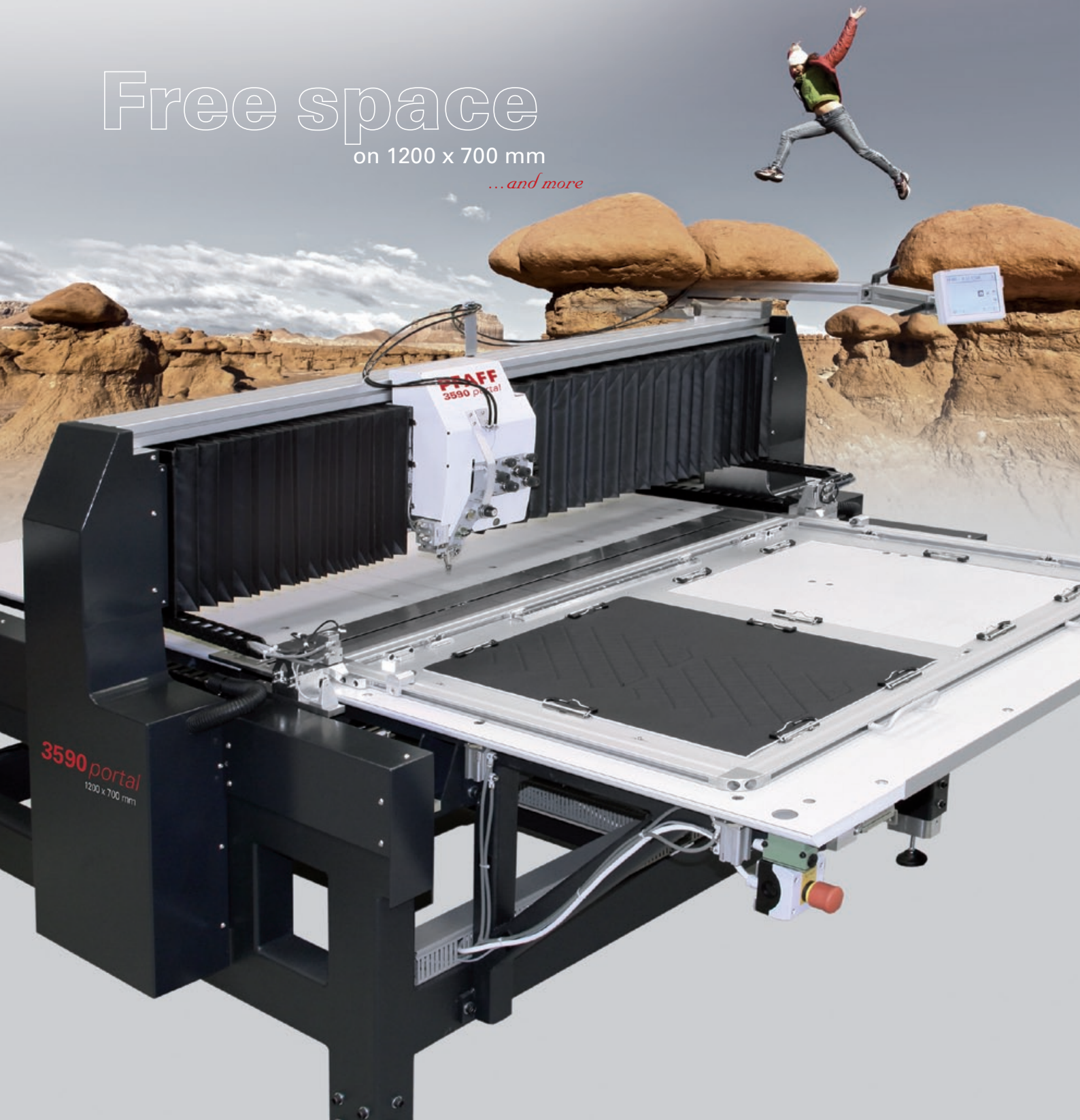

3590 *portal*



PFAFF Portal

Free space

on 1200 x 700 mm

...and more



Freely programmable large-field computer stitchers of the new generation PFAFF 3590 portal are efficient sewing units "Made in Germany". Know how paired with experience and the latest technologies in engineering, drive and control technology, set the pattern when it comes to reliability and process security. The sophisticated sewing technology based on our marathon vertical hook and an unique seam optimizing system provide the highest seam quality and a perfect stitch quality in multidirectional sewing over the whole sewing area. All complex top-stitch and decorative stitching operations can be mastered with this new PFAFF 3590 portal.

Versions:

Machine	Single needle version	Sewing area (x / y) *
3590	-51/12070	1200 x 700 mm
3590	-51/9060	900 x 600 mm

Maschine	Double needle version	Sewing area (x / y) *
3590	-52/12070	1200 x 700 mm
3590	-52/9060	900 x 600 mm

Customers requirements on request!

* X - Traverse way: sewing head, driven
Y - Traverse way: slide, driven



3590 *portal*

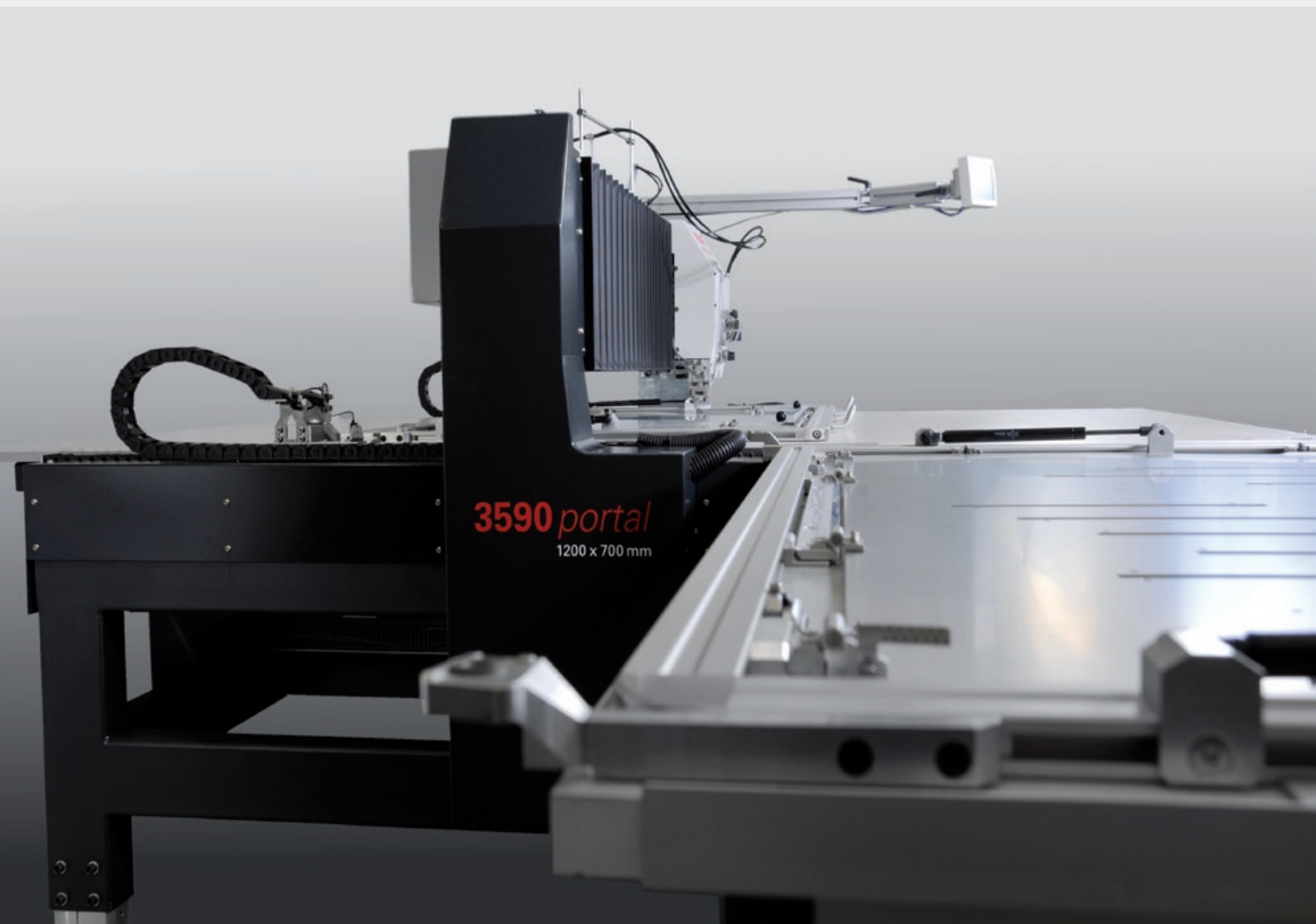

PFAFF Portal

Free space

on 1200 x 700 mm

...and more



Areas of application:

Complex stitching operations (also parallel seams) in the areas:

- Auto interior
- Car seats
- Airbag production
- Leather goods, bags
- Aircraft interior

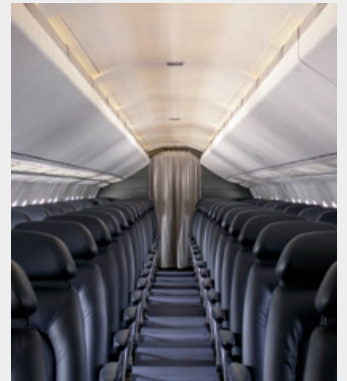

3590 *portal*

Sewing technology at its best:

The selection of the vertical hook guarantees highest quality seams. In combination with our "Stitch optimizing system" loop stitches are prevented.

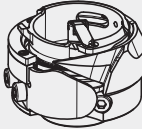
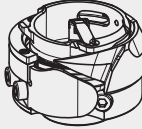
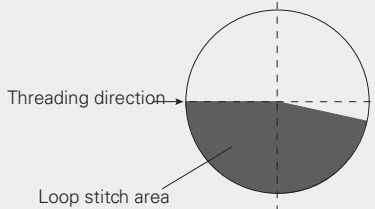
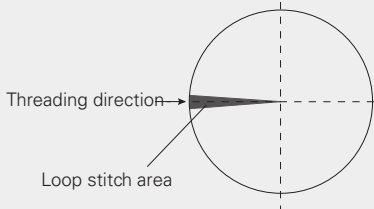
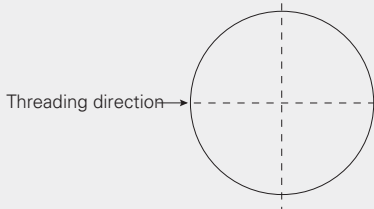
	Solutions with horizontal hook	PFAFF 3590 without device for an optimum stitch appearance	PFAFF 3590 with device for an optimum stitch appearance
Hook	 horizontal hook	 vertical hook	 vertical hook
Loop stitch area	 Threading direction → Loop stitch area	 Threading direction → Loop stitch area	 Threading direction →
Result	irregular loop stitches (in a large area)	uneven loop stitches (in a small area)	perfect stitch formation

PFAFF Portal

Free space

on 1200 x 700 mm

...and more

Jumping foot, separately driven via stepping motor:

- The stepping motor driven jumping foot is infinitely variable to 9 mm.
- Adjustments are made on the operator control panel or by programming in the sewing program. Therefore the foot is perfectly set for the material sewn.
- The time of set-down and lift-up of the foot is programmable and ensures reliable thread trimming and seam start.
- The from the needle bar independent driven jumping foot with the counter presser, guarantees highest quality stitch formation.

Conventional, intermittent jumping foot:

The foot pressure is fixed

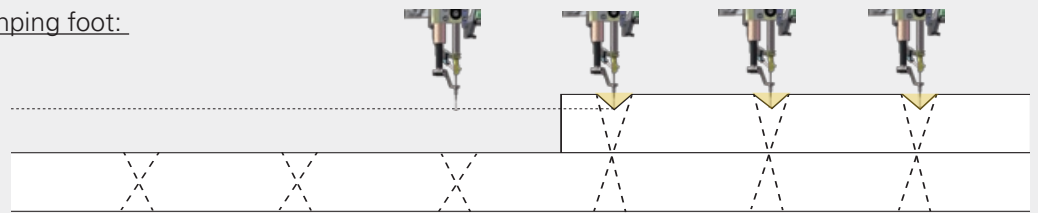

Programmable, intermittent jumping foot (PFAFF Portal)

The programmable lifting motion adjusts itself to the material

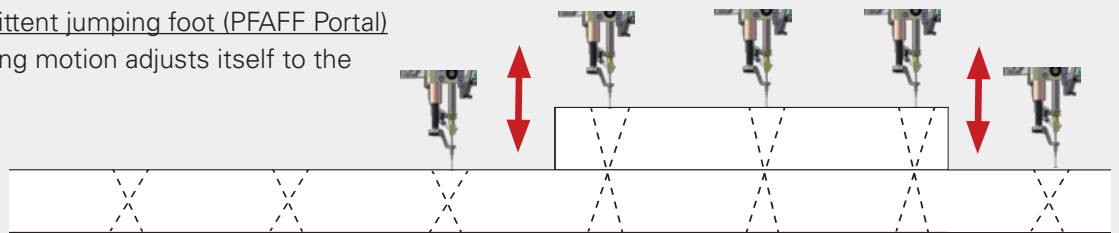

3590 *portal*

New "Marathon Hook" - for a maximum performance !

The new "Marathon Hooks" presents a significant lubrication improvement which positively affects the running performance (at all speeds). The alloy increases hook wear significantly. A special hardening and handling process allows re-work to be performed (i.e. after a collision of the hook tip and needle by the operator).

Select your bobbin thread capacity:

XL Hook 26 mm Ø >= 50 m thread 40/3 --> 100%
XXL Hook 32 mm Ø >= 88 m thread 40/3 --> 170%



Hook body:
improved lubrication
due to 2 oil inlets,
effective at any speed
Patent-No. 10 2010 017 898.5

Newly designed bobbin base:
with oil reserve (lasered pads)
for improved running properties
Patent-No. 10 2010 017 897.7

PFAFF Portal

Free space

on 1200 x 700 mm

...and more

Coreless Bobbin: Longer running time - higher productivity (Option)

- Up to 3 times more bobbin thread capacity
- Less bobbin changes
- Less thread breakages
- Better seam quality

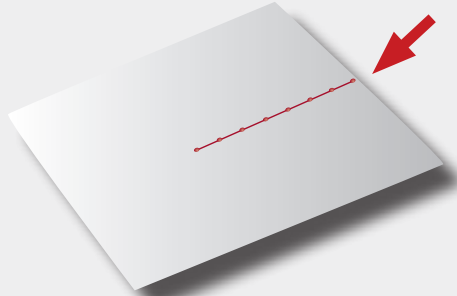

Device for reliable and secure seam start

WITHOUT secure start device	WITH secure start device (3590 portal)
<ul style="list-style-type: none">• Bobbin thread jumps out of nipper• Bobbin thread slips out of the loop	<ul style="list-style-type: none">• A controlled thread nipper for needle and bobbin thread ensures reliable seam start within two stitches.• The bobbin thread is held securely during the first stitch. The opening of the bobbin thread nipper can be set by stitch count
	



3590 *portal*

Equipment/Features: Single-needle version (-51/...)

- Special automatic sewing head
- Programmable (continuous) jumping foot with counter presser up to 9 mm lift (patent pending)
- Very accurate seam quality. Due to the intermittent feed (feed stops when needle enters material), shifting of the material in the work clamp is avoided
- Floating foot for the sewing template
- Sewing head tilts 70 mm for easy material handling
- Emergency stop system which cuts off the complete power supply (not the air supply)
- Hook saddle with XL vertical hook 26 mm (option: XXL 32 mm) diameter
- Electro-mechanical bobbin thread winder (separate device)
- Thread monitoring:
 - Needle thread monitor via sensor
 - Bobbin thread monitor via sensor
- 1 electro-mechanical bobbin winder can be flexible positioned
- Adjusting gauge with open sewing area for test seams (Option)
- Kit with needle-bar turning device and bobbin thread slide for an optimum stitch appearance to avoid loop stitches on highly decorative seam patterns with circular seams
- Kit for reliable and secure seam start by controlled thread clamps (top/bottom) consisting of:
 - Bobbin thread clamp device
 - Needle thread wiper
- Original PFAFF Industrial machines have an additional security label with several security features on the machine head. The advantage of this security label is the protection against growing product piracy.



PFAFF Portal

Free space

on 1200 x 700 mm

...and more

Equipment/Features: Double-needle version (-52/...)

- Special automatic sewing head (double-needle) with needle gauges: 6, 8, 10 mm
- Assymmetrically (moved to the left) needle bar/holder
- Hook saddle with XXL vertical hook 32 mm (option: 26 mm)
- Kit with needle-bar turning device and bobbin thread slide for an optimum stitch appearance to avoid loop stitches on highly decorative seam patterns with circular seams

Equipment/Features: Controlling/Software

- Clamp monitoring via RFID (Radio Frequency Identification)
- Automatic selection of program numbers
- Touch screen control panel P1 with integrated SD card reader
- Seam correction and seam programming on operator panel
- 5 level password protection (e.g. operator, supervisor, mechanic, plant manager, distributor)



3590 *portal*

Options:

- Needle cooling system
- Preparation table:
 - With positioning support for the clamp frame, electro-pneumatically controlled
 - Holder / bolting of the open template cover
 - Stacker for the clamp frame and the templates
- Additional clamp frames (needed to mount templates)
- Clamp monitoring via stationary barcode scanner (by customer specification)
- Internal network connection possible (to customers specification)
- Programming system PSP 5 (PFAFF STITCH PROGRAM) with USB copy protection
- External diagnostic port for service support

PFAFF Portal

Free space

on 1200 x 700 mm

...and more

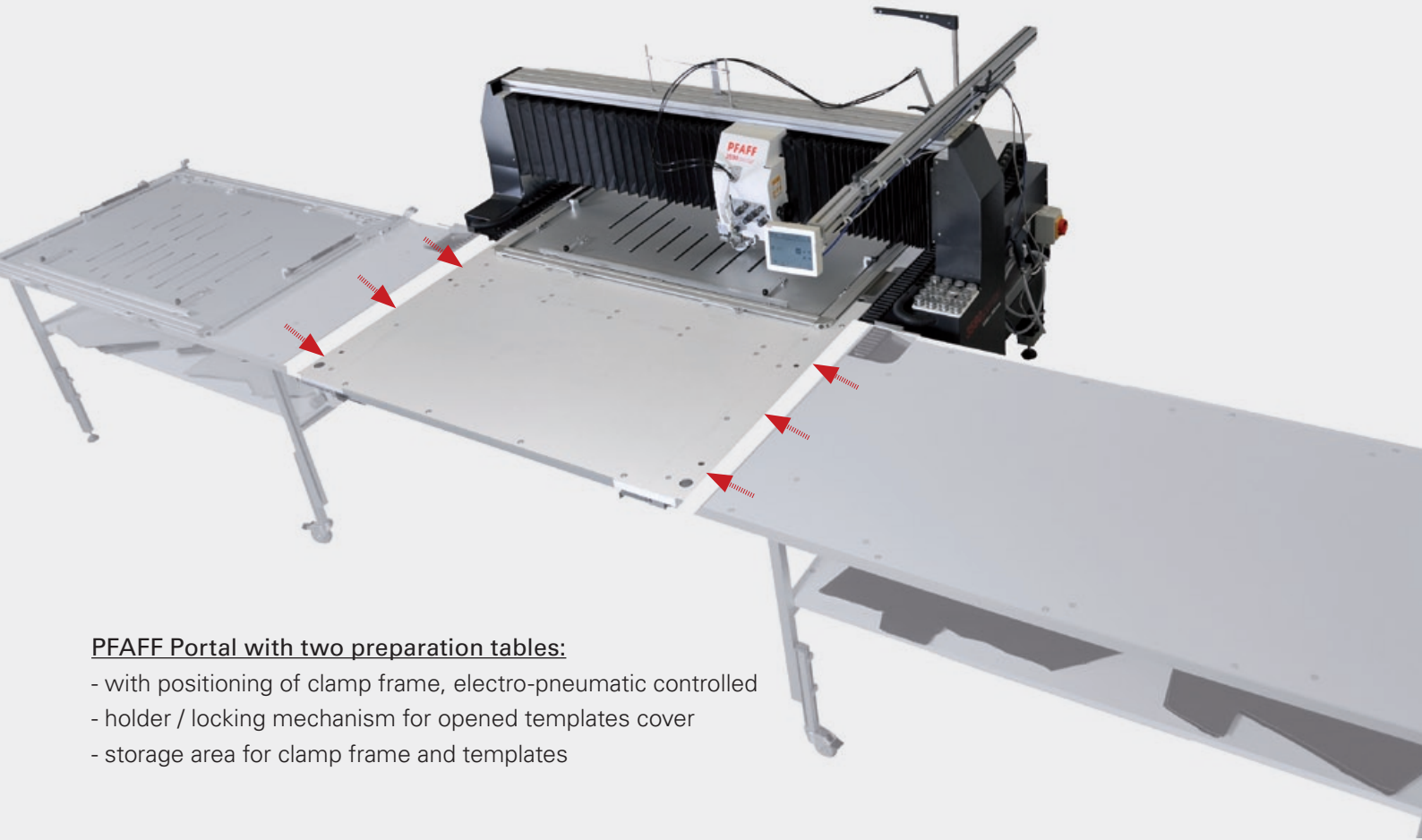

PFAFF Portal with two preparation tables:

- with positioning of clamp frame, electro-pneumatic controlled
- holder / locking mechanism for opened templates cover
- storage area for clamp frame and templates



Seam programming and data transfer via PSP

(PFAFF STITCH PROGRAM)

What is PSP ?

- PSP is a program for creating seam patterns

What is PSP capable of ?

- Free programming of individual seam types with the use of graphic elements, such as: straight line, curve, circle, ellipse, rectangle, square
- Entering specific commands for a machine
- Using background graphics (bitmaps) as a model for programming specific seam patterns
- Additional tools for defining the exact seam pattern are the zoom function and a variable gride superimposition
- Import and export of DXF files

Requirements for PSP ?

- PSP can run on every PC or laptop (Windows 2000 and higher) with the possibility of transferring data via SD-card, SD slot or USB/SD adapter

PFAFF Portal

Free space

on 1200 x 700 mm

...and more

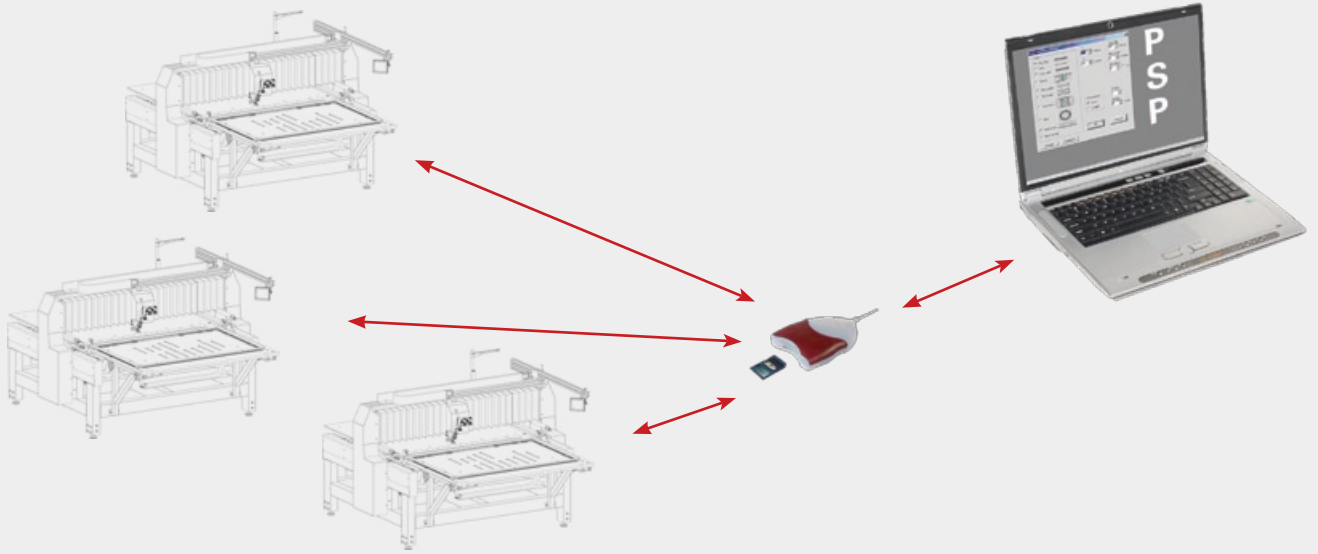

Technical Data:

Needle system:	134-35 KK
Needle size:	80 # 160 Nm,
Thread trimming:	up to 10/3 synthetik
Thread ends:	max. 13 mm
Max. needle thread size:	10/3 Synthetik
Max. bobbin thread size:	15/3 Synthetik
Bobbin thread capacity:	Hook Ø 26 mm → 50 m (Thread size: 40/3) Hook Ø 32 mm → 88 m
Jumper foot lift:	9 mm, continuous pre-selectable
Clearance: under the retainer	25 mm
Sewing head lift:	70 mm
Speed, max.:	2,000 Stiches/min. (depending on application)
Stitch length, max.:	12.1 mm
Intermittent feed:	up to max. 3,5mm stitch length with max. 1,500 stitches/min.
Noise indication:	LpA < 78 dB (A)
Net weight of the: 3590-51/12070 3590-52/12070	≤ 1,000 kg
Dimensions (L x B x H)	2,400 x 2,050 x 1,600 mm



Europäische Union
Wachstum durch Innovation – EFRE

PFAFF Industriesysteme und Maschinen AG

Hans-Geiger-Str. 12 – IG Nord
D-67661 Kaiserslautern

Telefon: +49-6301/3205-0
Telefax: +49-6301/3205-3171
E-mail: info@pfaff-industrial.com